

AWEA[®]

THE ULTIMATE MACHINING POWER



Journal⁰⁵

*Ultimate Machining Power
High Performance Machine Center*



CONTENTS

05 - 06	Operation Centers	29 - 30	MB Series
07 - 08	Professional Manufacturing	31 - 32	BL Series
09 - 16	Core Technology	33 - 34	VP / SP / LP Series
17 - 18	CRM / Human Resources	35 - 36	LG Series
19 - 20	MVP Series	37 - 38	FM Series
21 - 22	HTP Series	39 - 40	BM Series
23 - 24	LP-F Series	41 - 42	AF Series
25 - 26	MEGA5 Series	43 - 44	AT Series
27 - 28	FMV Series	45 - 46	The Product Line-up



WE insist **A** class production

Focus in R&D, insist in quality

AWEA dedicates in the machine tool's performance and technology innovation.

We always insist on providing the best quality product to every user.

Looking forward to growing together with customers.



Friction Stir Welding

FSW Series

High efficiency, environmental friendly, wider application

Opening new chapter for welding requirements.



Horizontal Boring Mills with APCs

MB-1512 APC

Auto pallet changer reduces the work-piece loading unloading time

Increases machining efficiency.



NC Intelligence

i Console

Optimized parameter, work-piece measurement,...etc

Make your machine smarter.



High Speed Tapping Centers

AT-510

Fast acceleration, and high efficient tool change mechanism

Provide you the max production capability.



AWEA MECHANTRONIC CO., LTD Ltd.
EDWARD TE-HWA YANG, PRESIDENT

Edward TH Yang

HONORARY PRESIDENT OF PRECISION MACHINERY DEVELOPMENT
ASSOCIATION OF TAIWAN

HONORARY PRESIDENT OF TAIWAN MACHINE TOOL AND ACCESSORY
BUILDER'S ASSOCIATION

HONORARY PRESIDENT OF MANUFACTURERS ASSOCIATION OF
TAICHUNG INDUSTRIAL PARK



亞歲機電

Established in 1986, AWEA has always been recognized as a quality and professional machine tools leading company. We have been continuously challenging ourselves and proudly present new machines this year including the Extra Large Span Gantry Type Machining Center and Gantry Type 5-axis Machining Center. Thanks to our customers over these years, AWEA's brand name is becoming more steady and mature. We will continuously provide high quality products and service and hope to grow stronger along with our customers.

We want to thank our customers for their long support and care over these 27 years. Thanks to their valuable suggestions and feedback, we will provide more quality products with improved performance and service with fast response. We hope that in the future our customers and AWEA will build a trustful relationship and grow stronger together.

Operation Center

Expanding our representation globally, providing the best local service



CTSP BRANCH ■ Manufacturing and sales of bridge type and C-frame vertical machining centers / 26,600 m²

With over 27 years of machining center manufacturing experiences, AWEA has gradually expanded its network throughout the world with companies in Hsinchu, Central Taiwan, USA (YAMA SEIKI), Shainghai (BEST WAY), Suzhou (DAWEA), Suzhou (AWEA), and South China office. Meanwhile we are continuing to build more factories which are located in Chiayi Dapumei, Taiwan this year in order to meet the increasing needs of our customers.

HEADQUARTERS

■ Manufacturing and sales of bridge type machining centers and boring mills / 26,000 m²



RESEARCH AND DEVELOPMENT CENTER

■ Hsinchu : R&D Bridge Type Machining Centers
■ Taichung : R&D Vertical Machining Centers





GLOBAL SALES & SERVICE NETWORK

	America	Europe	Asia	Taiwan	Other
Market Distribution	15 %	20 %	34 %	30 %	1 %



- 1 **TAICHUNG DA-YA BRANCH**
Manufacturing of C-frame vertical machining center / 3,300 m²
- 2 **YAMA SEIKI USA, INC.**
Sales of bridge type and C-frame vertical machining centers / 20,000 m²



- 3 **SUZHOU (AWEA)**
Manufacturing of bridge type and C-frame vertical machining centers / 66,800 m²
- 4 **SHANGHAI (BEST WAY)**
Manufacturing and sales of bridge type and C-frame vertical machining centers / 8,600 m²



- 5 **SOUTH CHINA SALES OFFICE**
Sales of bridge type and C-frame vertical machining centers / 500 m²
- 6 **SUZHOU (DAWEA)**
Processing of large machine components / 13,900 m²

Professional Manufacturing

All steps followed the SOP to ensure best quality product are produced.



■ Casting aging

Aged for up to 3 to 6 months to ensure maximum structural stability.



■ Casting machining

We use MITSUI SEIKI & TOSHIBA horizontal machining center to our parts.



■ Fine-grinding

SUMITOMO vertical grinding machine.



■ Work-piece measurement

WENZEL 3D measurement instrument



■ Clean room

All key components are assembled in a temperature controlled and dust free assembly laboratory.



■ Key components

Key components such as spindle bearing, gears, and curvic couplings are imported from major companies throughout the world.



■ Spindle, motor and gear unit dynamic balancing test



■ Headstock unit run-in test (thermal expansion, vibration, noise)

Machining



Assembly



■ Air conditioned production line – Hsinchu headquarters

Subassembly



■ Air conditioned production line – CTSP branch



QC



■ Ball bar for 3 axes



■ Linearity check



■ Accuracy check by laser

Core Technology | 5-axis machining solution

Comprehensive product range, provide solution for all kinds of application.

Advantages

Compound Angular Cutting

Provide simultaneous machining solution for intricate free curve machining.

Better Accuracy

Free machining angel selection ensures the best cutting approach.

- 5-axis can cut side-filler machining

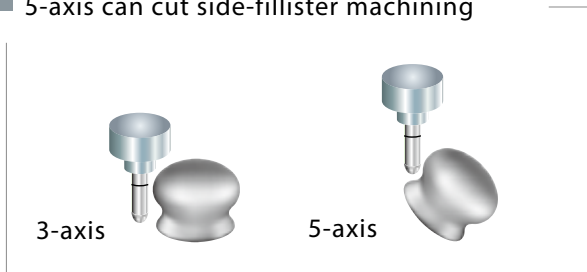

Shorter Machining Time

One-time setting can finish most programs.

Longer Tool Life

Cutting can be done in the middle part of the tool.

- 5-axis allows machining with shorter tool

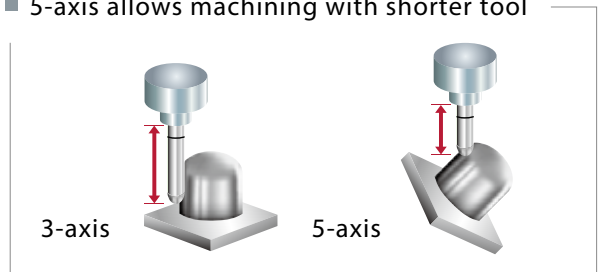

MEGA5 series



- 5-axis head with B, C axes.
- DD motor driven design.
- Suitable of large, complicated work piece. (such as stamping mold for cars)

LV series



- B,C axes rotary table, 5-axis simultaneous movement
- DD motor driven design
- Applicable for large composite work pieces. (full size of automobile, yacht molds).

FMV-99

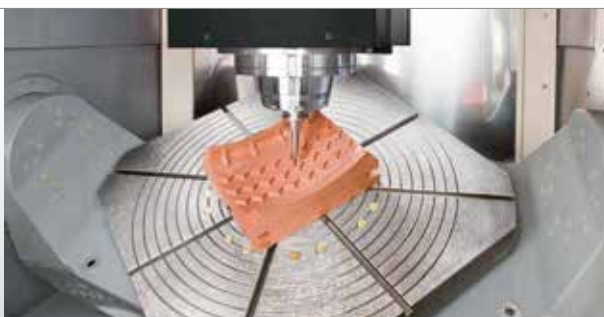

- A,C axes rotary table, 5-axis simultaneous movement.
- DD motor driven design.
- Applicable for compact precision components or moulds.

FMV-45



- B,C axes rotary table, 5-axis simultaneous movement.
- DD motor driven design.
- Applicable for compact precision components or moulds.

5-face machining solution

Comprehensive product range, provide solution for all kinds of application.

AWEA self-made 5-face machining module

Horizontal / Vertical ATC

All tool exchange movements and tool change point are assured by sensors and time sequence scan.

Automatic Head Storage compartment

High performance multiple head storage & high efficiency double head storage solutions are available for selection.

Attachment Heads

Complete angular head solutions precision hand scraped surface for attachment head and head cap and positioning by Japanese made curvic coupling.

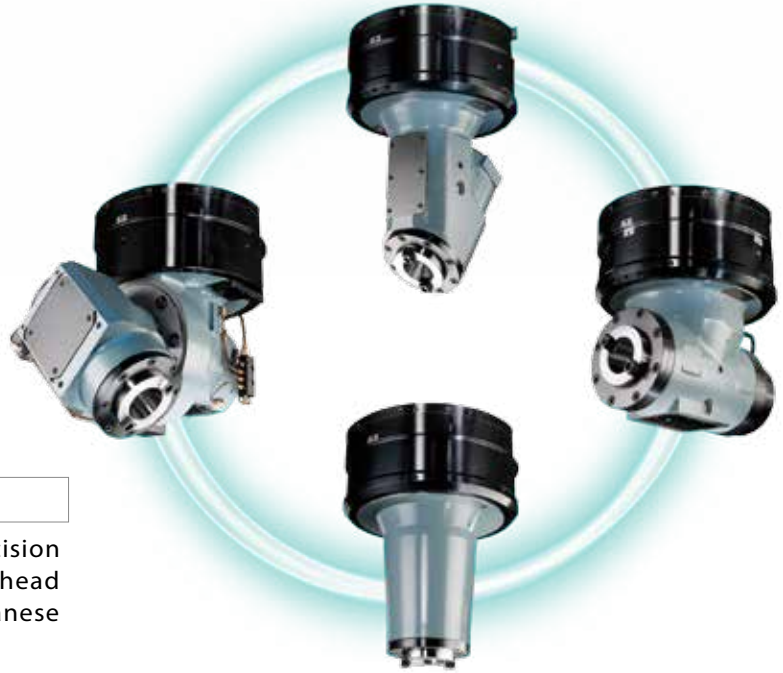

MVP series



- Moving cross rail structure, W-axis travel : 1,250 mm
- Automatic multiple head storage compartment
- Applicable for extra high components of 5-face machining.

HTP series



- Super rigidity head structure, 3 linear guide in saddle, 4 linear guide in head
- Double head storage capable of auto head load / unload

HVM series



- Multiple head storage capable of auto head load / unload
- Large size machining

LP-F series



- Double head storage capable of auto head load / unload
- Middle size machining

Core Technology

Large Machines Development Capability

Experienced R&D capability of combined precision, high rigidity and high performance for large machining centers.

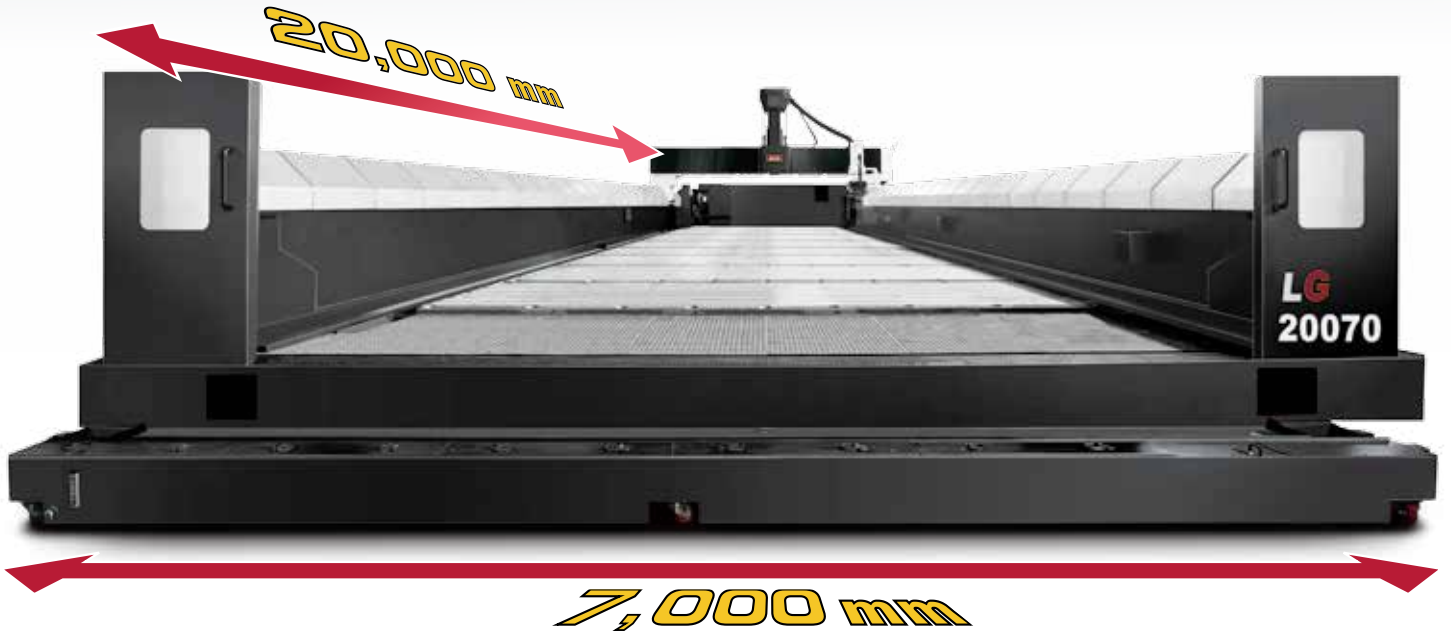

Crossbeam Adjustment Mechanism

PAT. No. : M377276

AWEA's latest development, the "Crossbeam Adjustment Mechanism" greatly overcomes the deformation problem of the large beam span which maintains a great amount of precision. The LG-20070 model is shown below.

Without Adjustable Crossbeam Mechanism

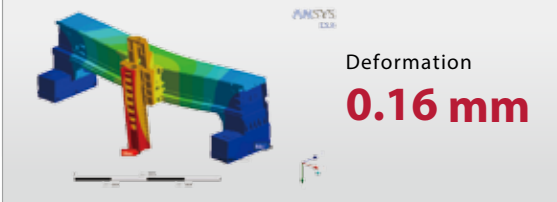

With Adjustable Crossbeam Mechanism

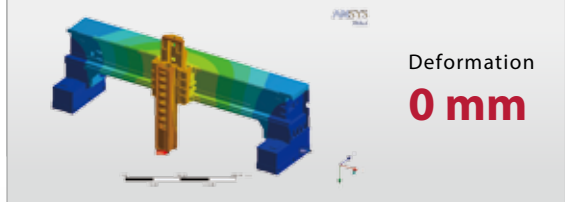

JB Series

Heavy Load Floor Type Horizontal Boring Mills

X / Y / Z / W axes travel : 10,000 / 3,600 / 450 / 900 mm

Max. table load : 20 tons

Auto exchange head storage

Elevator operating chamber

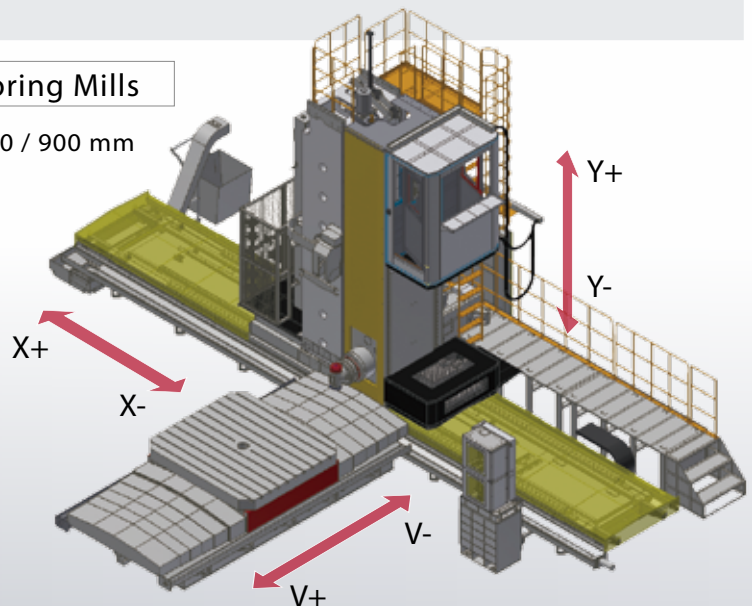
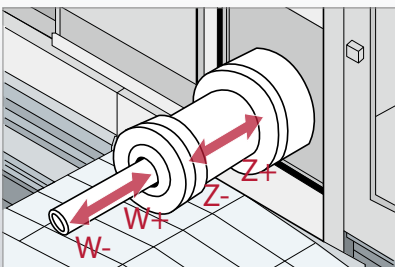

Friction Stir Welding (FSW)

Reliable, high efficiency, low pollution, low cost, wide application



FSW Technology

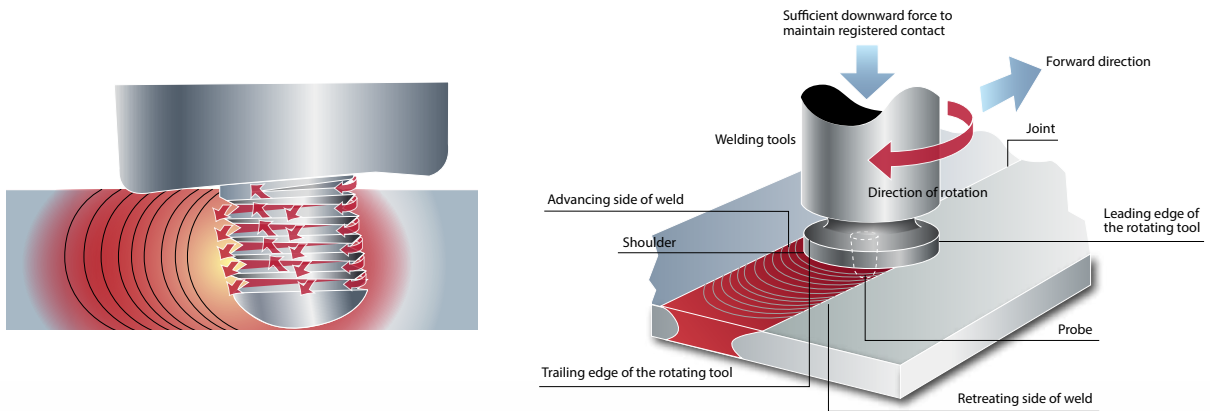

• Friction ➡ Stir ➡ Material fusion ➡ Plasticized material re-construction ➡ Cooling and set

Requirement

- Spindle torque
FSW needs powerful torque and high rigidity structure.
- Adaptive feed rate
Only adaptive feed rate makes the welding quality.
- Z-axis thrust
Powerful Z-axis thrust ensures the welding surface between the tool & the work piece is perfectly contacted, producing plasticized material re-construction.

Advantage

- TWI authorized (Taiwan Exclusive).
- Huge database for variety of material application.
- No filler wire required for most materials.
- No pre-heat, no pre-treatment, little pollution, no splash hazards.

Core Technology

| Hand Scraping

工藝



High precision machine tools come from exquisite hand scraping skills. AWEA's well trained hand scraping team makes sure that all contact surfaces are precisely hand scrapped and carefully inspected to ensure the highest quality of our machines.





Standard Hand Scraping Platform

- Maintained monthly by skilled technicians and is annually inspected by the 3D coordinate measuring machine.
- Platform flatness : 0.005 mm

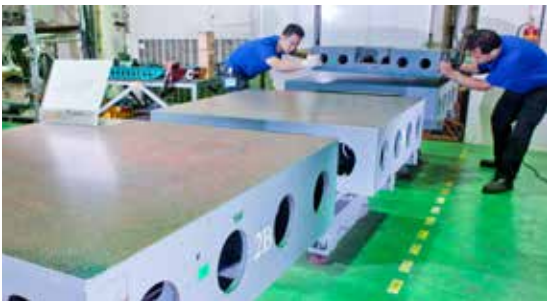

Heritage Craftsmanship

All scraping technicians are trained in house by senior. Keeping the standardized art level and quality.



Hand-scraping Density

- Fixed surface hand-scraping density : 10 ~ 15 dots / square inches
- Sliding surface hand-scraping density : 15 ~ 20 dots / square inches

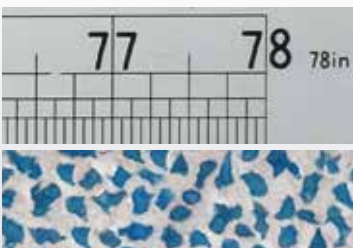

Fixed Surface of Key Components

While others only hand scrape moving surfaces, AWEA also hand scrapes fixed surfaces that influence the precision such as the main spindle connecting area and motor connecting plate.

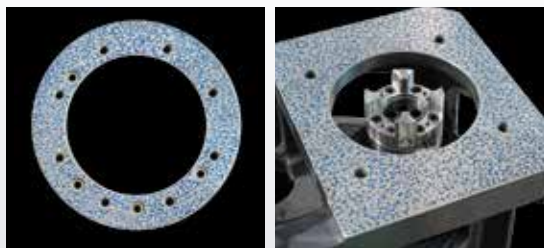

Core Technology

NC Intelligence

AWEA's self-developed **i Console** intelligent software enhancement system provides you with a user-friendly interface, real-time machine status information and dialogic functions. It not only effectively reduces complex working process but also increases intelligent machining abilities.



General features status display

- Real-time machine status
- Tools list
- Work piece measurement
- M code description
- PLC function
- Calculator
- Spindle thermal expansion compensation (Opt.)



Trouble shooting

When the alarm appears, the screen will display the malfunction message and trouble shooting procedure enabling the operator to solve easy problems to shorten the shutdown time.



Tool length offset

After manually measuring the tool length, the controller will automatically calculate the tool tip position and enter the data into the tool length offset table



Circular work piece measurement

By measuring the A, B, C three points coordinates the circular work piece's center point can be correctly calculated.



Adaptive feed control

Adaptive feed control is capable of real-time monitoring the spindle load to control the axial feed rate which effectively extends tool life, shortens rough cutting time, and detects abnormal cutting conditions.



Rectangular work piece measurement

By measuring the A, B, C, D, and E five points coordinates, the rectangular work piece's center point and slant angle can be calculated. Then the center point coordinate can be entered in the work piece coordinate system. (G54 – G59).



CNC parameter optimization

From rough cutting to fine finishing, the operator can select various cutting modes based on the working condition, and then set the allowable error and work piece weight to obtain the optimum parameter.

i Console

Make Your Machine Smarter

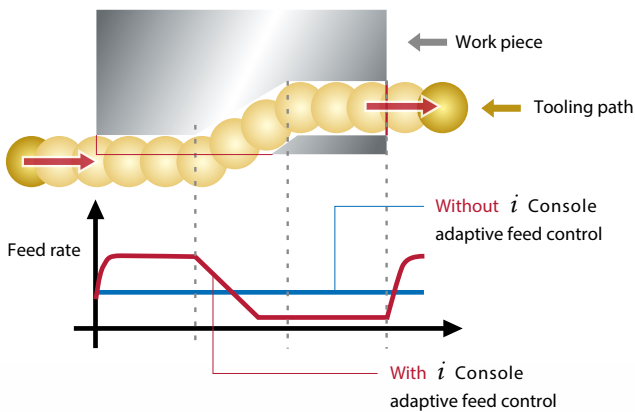

Adaptive feed control

Spindle load	Axial feed	
Below setting value	→	feed increase
Above setting value	→	feed decrease

Spindle load = Setting value

Cutting Error

- Slow feed rate brings ultra small cutting error
- Fast feed rate brings small cutting error
- Super fast feed rate brings large cutting error

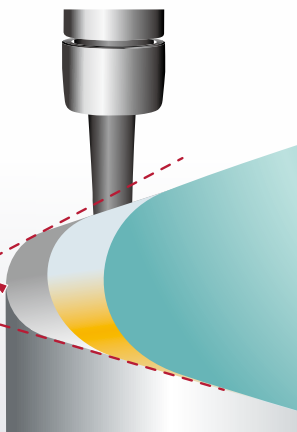

CNC parameter optimization

Based on feed rate difference for automatic corner deceleration, the smaller the setting value the better the accuracy but the cycle time relatively longer; to set feed rate difference in every axis with this parameter in order to calculate the deceleration at corner.

Service

Professional, swift, responsible



■ Basic trouble-shooting on-line



■ Professional technicians



■ High efficient service



■ Sufficient spare parts

Customer Relationship Management System

CRM system is implemented to improve our customers' satisfaction. With CRM complete solution and cloud database, we can provide integrated sales activity from inquiry to after-sales service.

CRM Characteristic

- Based on the type of maintenance problems, automatically notify the commissioner to provide more professional service.
- Complete machine maintenance history, accurate understanding of the machine status.
- Comprehensive technical service database to provide faster and reliable solutions.
- Instantly upload a survey about client's satisfaction to enhance service quality.

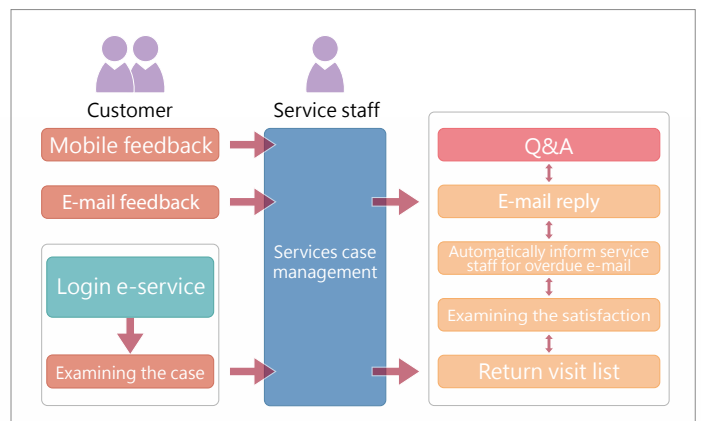

■ Service support framework

APP

Maintenance staff should check-in when arrive customer's factory immediately, then upload some photos about maintenance process onto our database to guarantee the quality and efficiency.



Human Resources Development

"Precision machining center technology" thematic award



To increase more talented human resource in machine to industry, AWEA & National Chung-Hsing University started a CNC machine tool technology competition project. This project was participated by all universities in Taiwan with very fruitful results.

After the competition President Yang instructed to continue same program in the future for bigger scale. With goals aiming for more professional machine tool industry talents would be generated.

Graduate School

1st Place High accuracy micro CNC M/C and 3D measurement development.
National ChangHua University of Education / Electric Engineering Dept.

2nd Place Intellectual micro machine tool and optical glass micron structure machining.
National Taiwan Normal University / Electric Engineering Dept.

3th Place Development for Non-contact energy transportation super sonic vibration aid taper.
National Chung-Hsing University / Mechanical Engineering Dept.

3th Place Precision aerostatic rotary table.
National ChangHua University of Education / Electric Engineering Dept.

3th Place Development for Advanced 5 axes machining center controller.
National Chung-Cheng University / Mechanical Engineering Dept.

Under Graduate

1st Place Research combining of Image-capturing & micro machining on micro shift movement.
National ChangHua University of Education / Electric Engineering Dept.

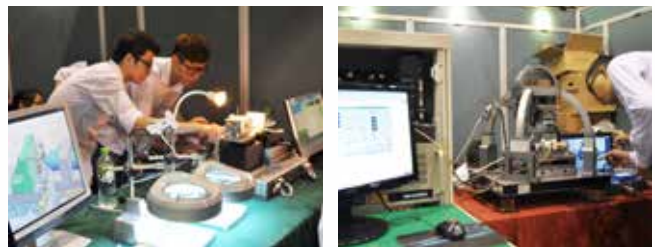

MVP

5-face Machining Center



Moving Cross Rail 5-face Machining Center

- W-axis is moving cross rail design, provide more machining flexibility.
- The multi-storage automatic head changer provides fully automatic multi-face cutting abilities for large working travels.
- Standard 60 tool magazine, with vertical / horizontal ATC system.
- Variety of size choice satisfies all kinds of need.
- Auto coordinate transfer system for angular head, saves program time.



Moving cross rail design increases rigidity & travel range >>

- W-axis adapts high rigid box-way suitable for heavy cutting.
- High stability of W-axis synchronized dual-servo control system.

W-axis travel
1,250 mm

Increasing Machining Rigidity

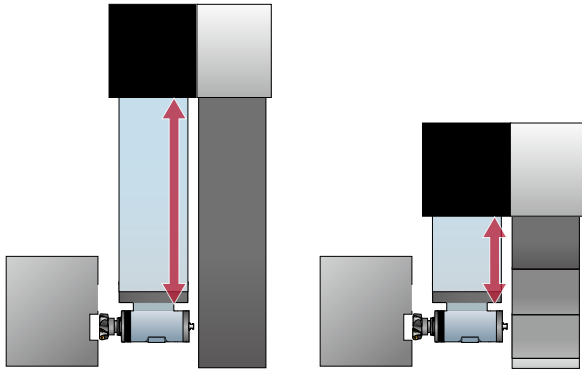

Traditional double column

Only Z travel is allowed, will have less rigidity when more extension.

Moving cross rail double column

Additional W-axis will reduce the Z-extension, providing better rigidity.

Expanding Machining Range

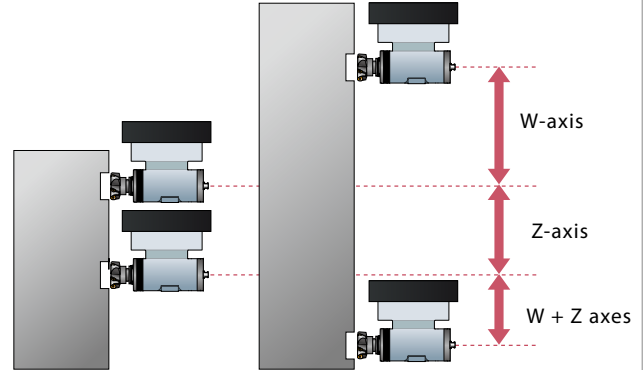

Traditional double column

W-axis allows more flexibility in machining.

Moving cross rail double column

Multiple Head Auto Storage



Horizontal / Vertical ATC



High Performance Structure

- 4,000 rpm, 2-steps, Gear spindle torque up to 977 N-m.
- Compound 4 guide way supports full travel range of the table, eliminate table distortion problem.
- X,Y Axes adapt roller linear guide way, providing heavy cutting rigidity and high accuracy.
- W-axis adapts high rigidity box way.

		MVP-4032	MVP-5032	MVP-6032	MVP-4040	MVP-5040	MVP-6040	MVP-7040
X-axis travel	mm	4,000	5,000	6,000	4,000	5,000	6,000	7,000
Y-axis travel	mm	3,200			4,000			
Z-axis travel	mm	1,000 (1,200 / 1,400 Opt.)						
W-axis travel	mm	1,250						
Dist. between columns	mm	2,680			3,480			
Table size (X x Y)	mm	4,020 x 2,400	5,020 x 2,400	6,020 x 2,400	4,020 x 3,010	5,020 x 3,010	6,020 x 3,010	7,020 x 3,010
Table load capacity	kg	15,000	18,000	20,000	15,000	18,000	20,000	
Spindle speed (V / H)	rpm	4,000 / 2,000						
Spindle motor	kW	22 / 26 (Cont. / 30 min.)						

HTP

5-face Machining Center



Super Rigidity 5-face Machining Center

- Super rigid headstock satisfies stringent heavy-duty machining.
- Y-axis adopts with three linear guideways and provides firmly support for headstock.
- 5-face coordinate transfer system reduces the program time.



Brand new high rigidity enforced structure design »

Headstock Structure



Z-axis adapts 4 linear guide way and 10 slider, which ensures the best head rigidity when extended.

Saddle adapts box-structure, which provides firmly support to the head. The cutting reaction can be dispatched to 10 sliders, ensures the accuracy.

4,000 rpm gear spindle with 26 kw power satisfies heavy cutting.

Head rigidity increases

40 %

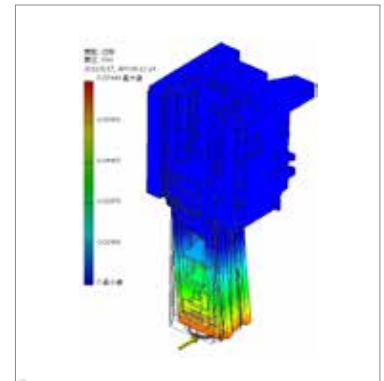
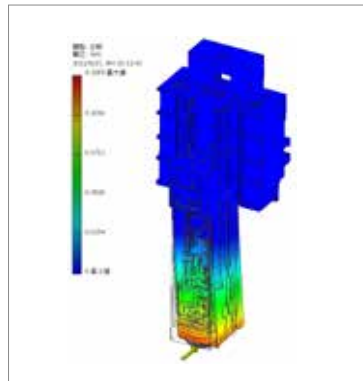

- Y-axis adapts 3 linear roller guide ways providing rigid supporting to the saddle.
- One-piece base adapts 4 linear guide way; base size increases with travel size, eliminate base distortion.
- Wide distance center-symmetric driven design, X-axis ball screw locates in the movement center, providing high accuracy and heavy load required axial thrust.
- Table adapts twin-layer rib reinforced vibration-proof hollow structure, increase cutting stability.

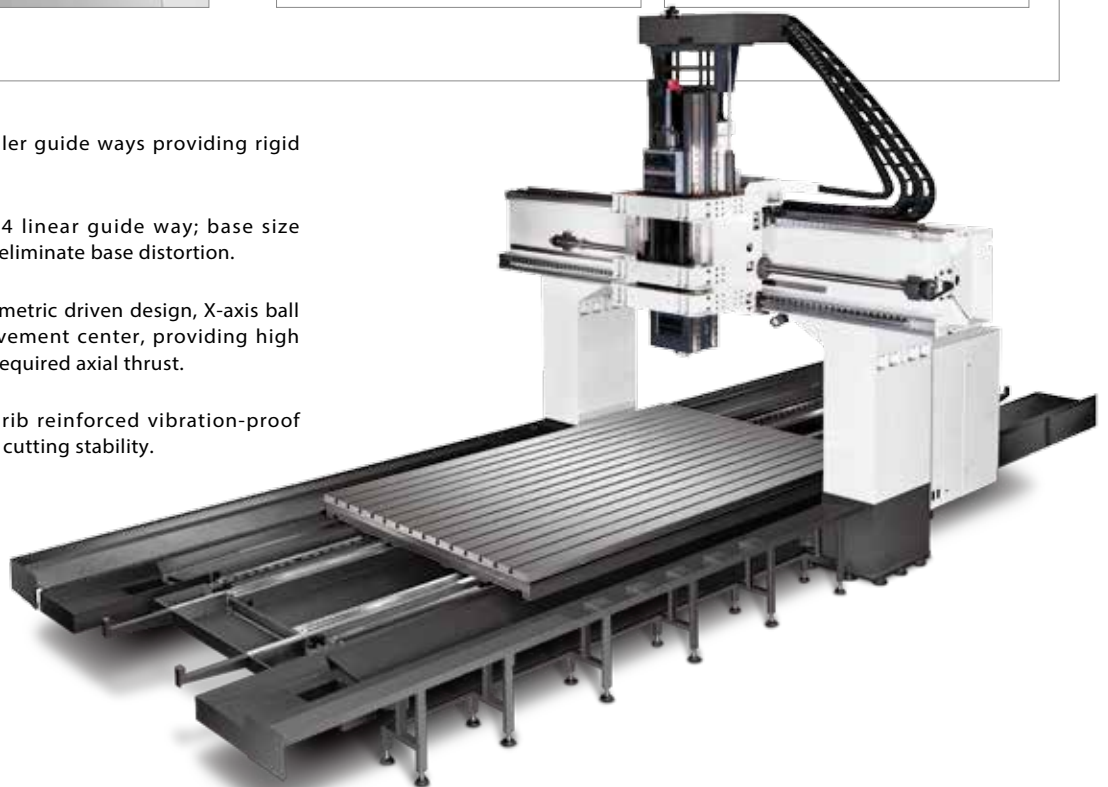

		HTP-4025	HTP-5025	HTP-6025	HTP-4033	HTP-5033	HTP-6033	HTP-7033
X-axis travel	mm	4,000	5,000	6,000	4,000	5,000	6,000	7,000
Y-axis travel	mm	2,500			3,300			
Z-axis travel	mm	1,000 (1,200 / 1,400 Opt.)						
Dist. between columns	mm	2,700			3,500			
Table size (X x Y)	mm	4,020 x 2,400	5,020 x 2,400	6,020 x 2,400	4,020 x 2,400	5,020 x 2,400	6,020 x 2,400	7,020 x 3,000
Table load capacity	kg	15,000	18,000	20,000	15,000	18,000	20,000	20,000
Spindle speed	rpm	4,000						
Spindle motor	kW	22 / 26 (Cont. / 30 min.)						

LP-F

5-face Machining Center



High Efficiency 5-face Machining Center

- With automatic load / unload head storage and horizontal / vertical ATC, it provides high efficiency, multi-functional 5-face machining capability.
- Complete production range, fits for all kinds of machining requirement.
- 5-face machining coordinate conversion system, saves program time.
- High quality with reasonable price provides the best investment returns.



High efficiency key components »

Vertical / Horizontal ATC System



Each tool change point and movement contains a sensor to ensure normal functioning during a tool change sequence. Standard capacity : 32T ; 60T / 90T / 120T opt.

Automatic Head Changer



Head storage adapts linear guideway, provides fast head exchange time.

Independent door to prevent chips from coming inside.



Modular spindle design, providing various cutting alternatives to meet with different working applications.

One-piece base structure built with complex 4 guide ways is enlarged proportional to the length of the travel to eliminate working table over hang issue while ensuring maximum structural support.

Base, column, cross beam, table, and head all adapt MEEHANITE casting or high rigidity welding structure; column & cross beam contact surfaces are precisely hand scrapped, ensures the maximum rigidity and balance.

		LP-2516YF	LP-3016YF	LP-4016YF	LP-5016YF	LP-3021YF	LP-4021YF	LP-5021YF	LP-6021YF
X-axis travel	mm	2,500	3,000	4,000	5,000	3,000	4,000	5,000	6,000
Y-axis travel	mm	1,900				2,400			
Z-axis travel	mm	760 (1,000 Opt.)				760 (1,000 / 1,200 / 1,400 Opt.)			
Dist. between columns	mm	1,700				2,300			
Table size (X x Y)	mm	2,310 x 1,500	3,260 x 1,500	4,200 x 1,500	5,000 x 1,500	3,020 x 2,010	4,020 x 2,010	5,020 x 2,010	6,020 x 2,010
Table load capacity	kg	8,000	10,000	12,000	14,000	10,000	12,000	15,000	18,000
Spindle speed (V / H)	rpm	6,000 (8,000 / 10,000 Opt.) / 2,000							
Spindle motor	kW	22 / 26 (Cont. / 30 min.)							

		LP-3025YF	LP-4025YF	LP-5025YF	LP-6025YF	LP-4033YF	LP-5033YF	LP-6033YF	LP-7033YF
X-axis travel	mm	3,000	4,000	5,000	6,000	4,000	5,000	6,000	7,000
Y-axis travel	mm	3,200				3,900			
Z-axis travel	mm	760 (1,000 / 1,200 / 1,400 Opt.)							
Dist. between columns	mm	2,700				3,500			
Table size (X x Y)	mm	3,020 x 2,400	4,020 x 2,400	5,020 x 2,400	6,020 x 2,400	4,020 x 2,400	5,020 x 2,400	6,020 x 2,400	7,020 x 3,000
Table load capacity	kg	12,000	15,000	18,000	20,000	15,000	18,000	20,000	20,000
Spindle speed (V / H)	rpm	6,000 (8,000 / 10,000 Opt.) / 2,000							
Spindle motor	kW	22 / 26 (Cont. / 30 min.)							

MEGA5

5-axis Machining Center



Bridge Type 5-axis Machining Center

- Strong horsepower 50 kW motor provides powerful machining capability.
- B, C axes adapt direct driven motors, zero back lash, higher accuracy.
- Suitable for big size and complicate work piece .
- HEIDENHAIN iTNC530 controller for advanced 5-axis cutting.
- **MEGA5 P** Fixed column type
 - High stability, full range, fits for all kinds of requirement.
- **MEGA5 G** Gantry type
 - Space-saving, heavy-loading, extra large machining range



High performance spindle, suitable for all kinds of machining requirement »



HSK-A100 High power spindle

Max. speed	Max. output	Max. torque
12,000 rpm	50 kW	314 N-m

HSK-A63 High speed spindle

Max. speed	Max. output	Max. torque
24,000 rpm	42 kW	87 N-m

Spindle Growth Chart

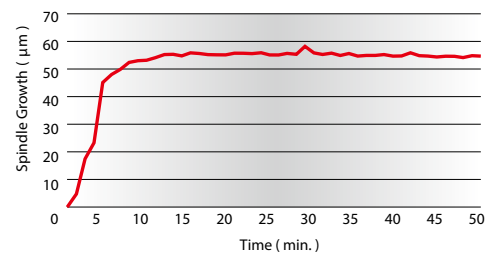

Stable spindle; spindle thermal deformation is confined within 0.01 mm range in very short time.

B / C axes adapt direct driven motors »

Maximum Performance DD Motor

B / C axes is adopted with Italian made direct driven motors, along with high performance disk type hydraulic braking system, providing higher accuracy, zero back lash and low wear out.



Positioning & clamping time

1 Sec.

Hydraulic clamping force

10,000 N-m

Super Rigidity Universal Milling Head

One-piece casting in GGG40 nodular graphite cast iron possesses higher rigidity and vibration damping capability.

With symmetric FORK structure design, cutting force can be evenly distributed, ensures the machining accuracy.

Hydraulic rigidity cross roller bearings (diameter B-axis : 150 mm / C-axis : 320 mm) can withstand higher axial load, radial load and coupled load in both direction.

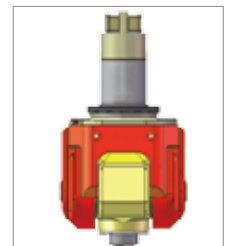

		MEGA5 P	MEGA5 G
X-axis travel	mm	3,000 ~ 7,000	4,000 ~ 20,000
Y-axis travel (V)	mm	2,500 ~ 4,000	3,700 ~ 6,700
Y-axis travel (H)	mm	1,800 ~ 3,300	3,000 ~ 6,000
Z-axis travel	mm	1,000 / 1,200 / 1,400	
Table load capacity	kg	12,000 ~ 20,000	2,500 (kg/m ²)
X-axis rapid feed rate	m/min.	10 ~ 20	
Y / Z axes rapid feed rate	m/min.	15 / 10	

		B-axis	C-axis
Max. spindle speed	rpm	50	50
Max. accel. speed	rad/sec ²	30	30
Continuous torque	N-m	1,400	1,450
Max. torque	N-m	2,200	2,400
Clamping torque	N-m	10,000	10,000
Positioning accuracy	arc.sec	± 3	± 3
Rotary range	deg	± 100	± 240

FMV

5-axis Machining Center



Gantry Type 5-axis Machining center



- High speed built-in spindle ensures long time machining accuracy.
- High performance rotary table increase machining efficiency and accuracy.
- Suitable for middle to small size machining.
- With HEIDENHAIN iTNC530 controller capable of 5-axis simultaneously.
- FMV-45 Series
 - With B, C axes design. max load is 300 kg
- FMV-99 Series
 - With A, C axes design. max load is 1,000 kg

High performance rotary table driven by DD motor >>

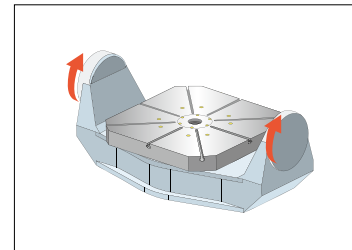
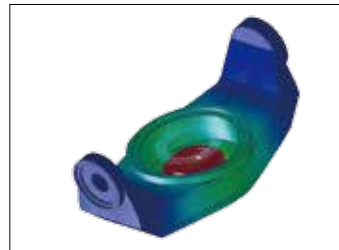

By using Finite Element Methods (FEM) and one-piece nodular graphite casting, the rotary table of the FMV series can provide outstanding ductility and anti-shock capabilities.

Rotary table is adopted with a circular hydraulic brake system. Its locking force is superior to conventional disk brake systems which can avoid the table from deforming.

Rotation axes are driven by high speed, high torque, zero back lash DD motor, installed with rotary encoder. Superior power transmission and also saves energy consumption.

	FMV-45	FMV-99
Swiveling range of A / B axes	B-axis : -180° ~ +160° / C-axis : 360°	A-axis : -120° ~ +30° / C-axis : 360°
Swiveling speed of A / B axes	B-axis : 30 rpm / C-axis : 100 rpm	A-axis : 30 rpm / C-axis : 100 rpm

- 1 FC300 meehanite high rigidity, one-piece U shape base.
- 2 Shortest spindle over-hang distance, provides required stiffness for heavy cutting.
- 3 Three points supported girder give spindle headstock and saddle strong supports.
- 4 High speed, high rigidity roller type linear guide way design.



FMV-45



FMV-99



		FMV-45	FMV-99
X / Y / Z axes travel	mm	500 / 450 / 450	800 / 900 / 660
Table load capacity	kg	300	1,000
Table size	mm	Ø 450 ; 400 x 400	Ø 990 ; 800 x 800
Spindle speed	rpm	16,000	
Spindle motor	kW	25 / 29 (Cont. / 30 min.)	
Spindle taper		BT40 / HSK-A63	
X / Y / Z axes rapid feed rate	m/min.	48	
Tool magazine capacity	T	40 (60 Opt.)	40 (80 Opt.)

MB

Horizontal Boring Mills



High Precision Horizontal Boring Mills

- The spindle is adopted with high precision quill which provide excellent machining accuracy and heavy-duty cutting capacity.
- The rotary table with hydrostatic bearing have high rigidity, anti-vibration, and low-wear advantages.
- The X / Y axes are equipped with high rigidity box ways which is suitable for various heavy cutting conditions.
- The Z-axis is adopted with compound guide ways to effectively prevent the table from overhanging while providing strong and firm support.



High torque gear spindle >>

High Precision Quill

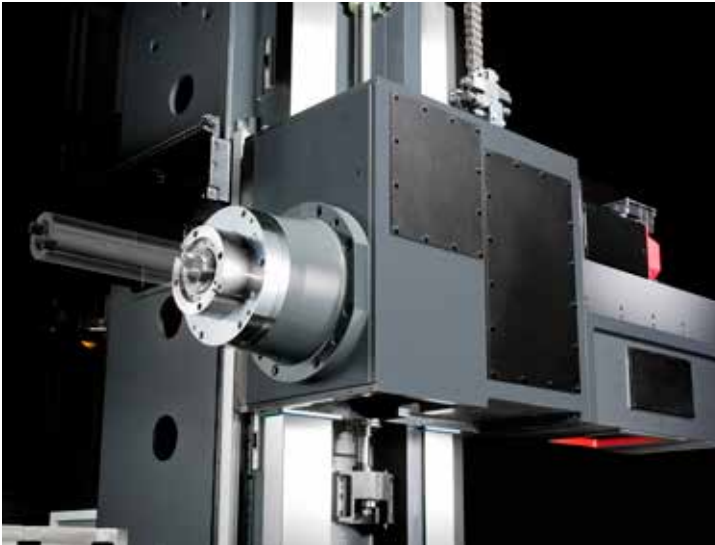

Maximum Torque

1,800 N-m

High rigidity closed spindle head design combined with spindle transmission and feeding system provides powerful heavy-duty cutting ability.

Max. spindle speed of 3,200 rpm with 3-step gear box can provide maximum torque output of 1,800 N-m under 137 rpm.

The system uses a $\varnothing 110$ mm high precision spindle which allows the W-axis travel to be up to 500 mm.

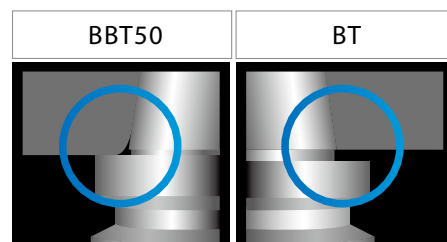

The inner taper of the spindle conforms with BBT50 tool to provide a firmer grip to the tools which reduces the vibration from the tools.

High performance rotary working table >>

The rotary table is supported with high rigidity base which gives full travel support, to prevent overhanging problems and maintain accuracy over long working hours.

Hydrostatic bearings with high resolution linear scales provide strong support, ant-vibration features, low-wear and long life-term advantages.

The B-axis positioning uses a powerful hydraulic braking system to provide positioning accuracy in any indexing. The right angle indexing lock device allows the 90° indexing with more stability.

APC system as an option to enhance working efficiency.



MB-1512		
X-axis travel	mm	1,500
Y-axis travel	mm	1,200
Z-axis travel	mm	900
W-axis travel	mm	500
B-axis positioning accuracy	deg	0.001
Table size	mm	1,250 x 1,150
Boring spindle size	mm	$\varnothing 110$
Table load capacity	kg	4,000
Spindle speed	rpm	3,200
Spindle motor	kW	22 / 26 (Cont. / 30 min.)



BL

Horizontal Boring Mills



High Rigidity Horizontal Boring Mills

- Heavy-duty rotary table, maximum table load capacity reach up to 15,000 kg (Opt.).
- Modular spindle design to fulfill different kinds of cutting requirement.
 - BL-S series with quill type spindle, maximum torque output reach up to 1,308 N-m.
 - BL-FM series with ram type spindle, maximum spindle speed reach up to 8,000 rpm.

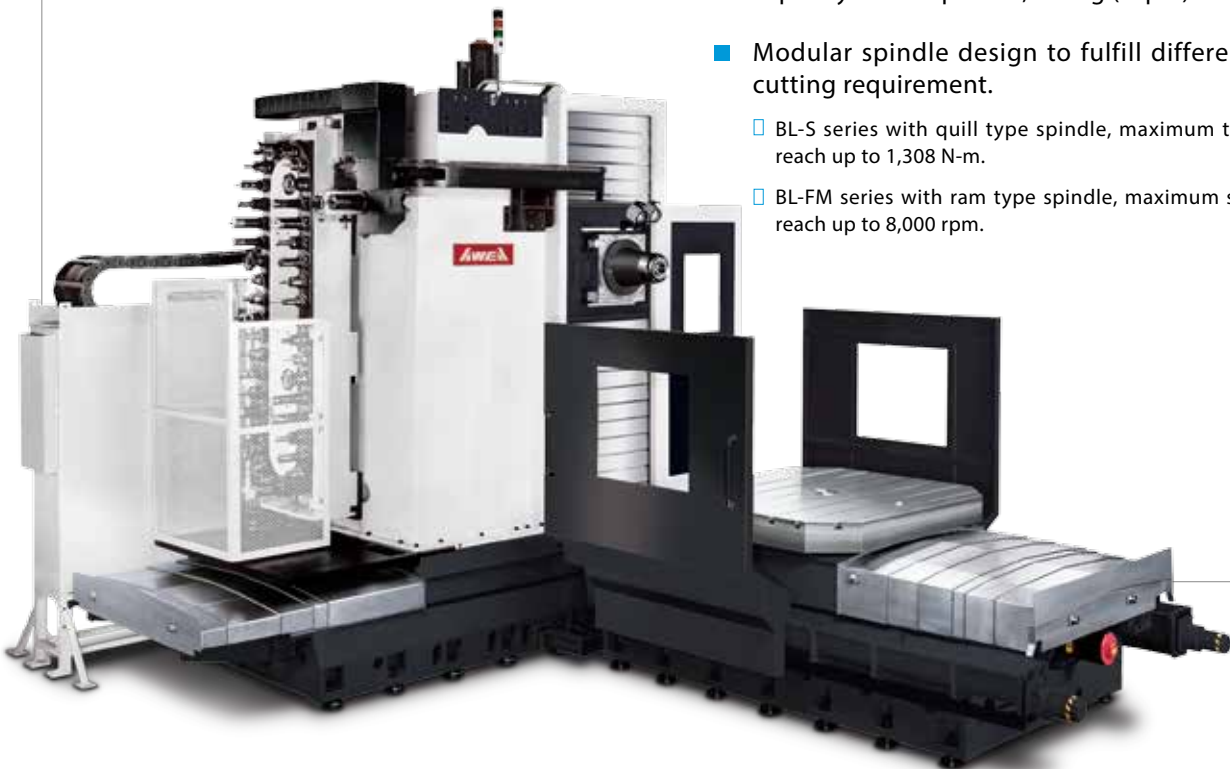

Modular high performance spindle >>

Parts Processing BL-S Quill Type Spindle



- Quill diameter $\varnothing 120$ mm · W-axis travel can extend to 600 mm.
- Max. spindle speed at 2,400 rpm with 2-step gear box which can provide maximum torque output at 1,308 N-m under 189 rpm.
- W-axis feed system combined ball screw with linear guide ways, W-axis extension can be determined according to different of processing requirement.

Mold Processing BL-FM Ram Type Spindle



- Strong ram with cross section at 480 x 470 mm, W-axis travel can be extended to 600 mm.
- Max. spindle speed at 6,000 rpm (8,000 rpm as option) with built-in spindle which can provide maximum torque output at 6,000 N-m under 350 rpm.
- W-axis feed system combined ball screw with linear guide ways, W-axis extension can be determined according to kinds of processing requirement.

- 1 High performance, low friction oil floating design working table provide maximum table load capacity at 15,000 kg (Opt.)
- 2 Long nose spindle design to shorten the distance between tools and parts, reinforcing rigidity when processing.
- 3 3 axes feed system is adopted with full travel support high rigidity linear guide ways to fulfill heavy cutting requirement.
- 4 HEIDENHAIN linear scale with resolution up to $1 \mu\text{m}$ as standard on 3 axes, assuring positioning accuracy ± 0.010 mm / full travel (JIS).
- 5 Two augers and caterpillar type conveyor as standard ensure chips removal efficiency and cooling effect.



BL-2018S / BL-3018S / BL-4018S		BL-2018FM / BL-3018FM / BL-4018FM	
X-axis travel	mm	2,000 / 3,000 / 4,000	
Y-axis travel	mm	1,800 (2,400 Opt.)	
Z-axis travel	mm	1,300 (1,700 Opt.)	
W-axis travel	mm	600	
Table size	mm	1,600 x 1,800	
Boring spindle size	mm	Quill with $\varnothing 120$	Ram 480 x 470 section
Table load capacity	kg	12,000 (Opt. 15,000)	
Spindle speed	rpm	2 Steps geared spindle 2,400	Built-in spindle 6,000 (Opt. 8,000)
Spindle motor	kW	22 / 26 (Cont. / 30 min.)	

VP / SP / LP

Bridge Type Machining Center

龍門世家

Maximum Performance Bridge Type Machining Center

- Modular spindle design provide different cutting characteristics.
- Comprehensive attachment head solutions to meet diverse cutting requirements.
- High rigidity bridge structure, strict process of assembly and quality control to provide machines outperforming peers.



Maximum performance bridge type machining centers >>

Comprehensive product lines with excellent quality and performance are reputed in the industry.



LP Series

SP Series

VP Series

X-axis travel	2,500 ~ 7,000 mm	2,100 ~ 4,000 mm	2,000 ~ 5,000 mm
Y-axis travel	1,600 ~ 4,000 mm	1,600 mm	1,200 mm
Z-axis travel	760 ~ 1,400 mm	760 mm	760 mm
Spindle speed	6,000 rpm	6,000 rpm	6,000 rpm
Spindle motor	22 / 26 kW (Cont. / 30 min.)	22 / 26 kW (Cont. / 30 min.)	11 / 15 kW (Cont. / 30 min.)

- 4 guide ways one-piece bed structure
- Optional 5-face machining function

- One-piece bed casting structure
- Optional high speed spindle

- One-piece bed casting structure
- Optional high speed spindle

Centro-Symmetric Spindle Sys.

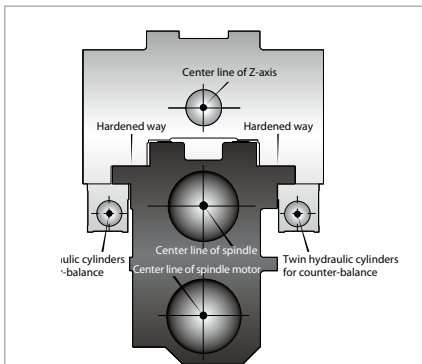

Hereby preventing thermal distortion and minimizing deflection. Assuring accuracy and heavy cutting capability.

Feedback System



The semi-closed loop circuit system which the ball screw end is directly connected to the encoder ensures high positioning accuracy.

Inner-rail Embraced Structure



Provides high rigidity and gains good stress flow which minimizes over hang and vibration issues.

Symmetrical center-driven design

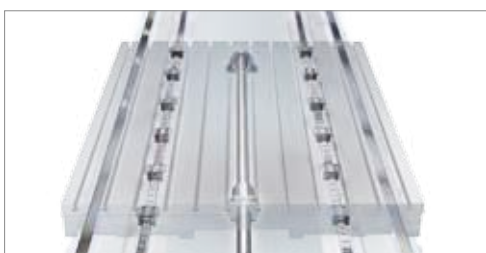

Wide span symmetrical center-driven with X-axis ball screw placed in the center of the axial movement provides high precision axial feeding features.

Y-axis Sectional Guide Ways Design

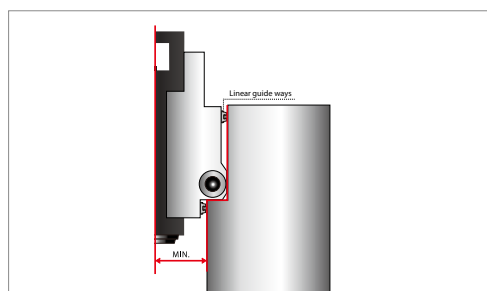

Increases structural rigidity reduces distance between spindle to cross beam enhances overall cutting performance.

LG

Gantry Type Machining Center



Gantry Type Machining Center

- Gantry type structure design, high accuracy, space-saving, efficient parts loading / unloading
- Max Y travel can reach 7 meter, the largest Y-axis span in TW.
- Floor type table, low vibration, max load can be 2,500 kg/m²
- Optional automatic head storage and horizontal / vertical ATC, providing 5-face machining capability for super large work-piece.

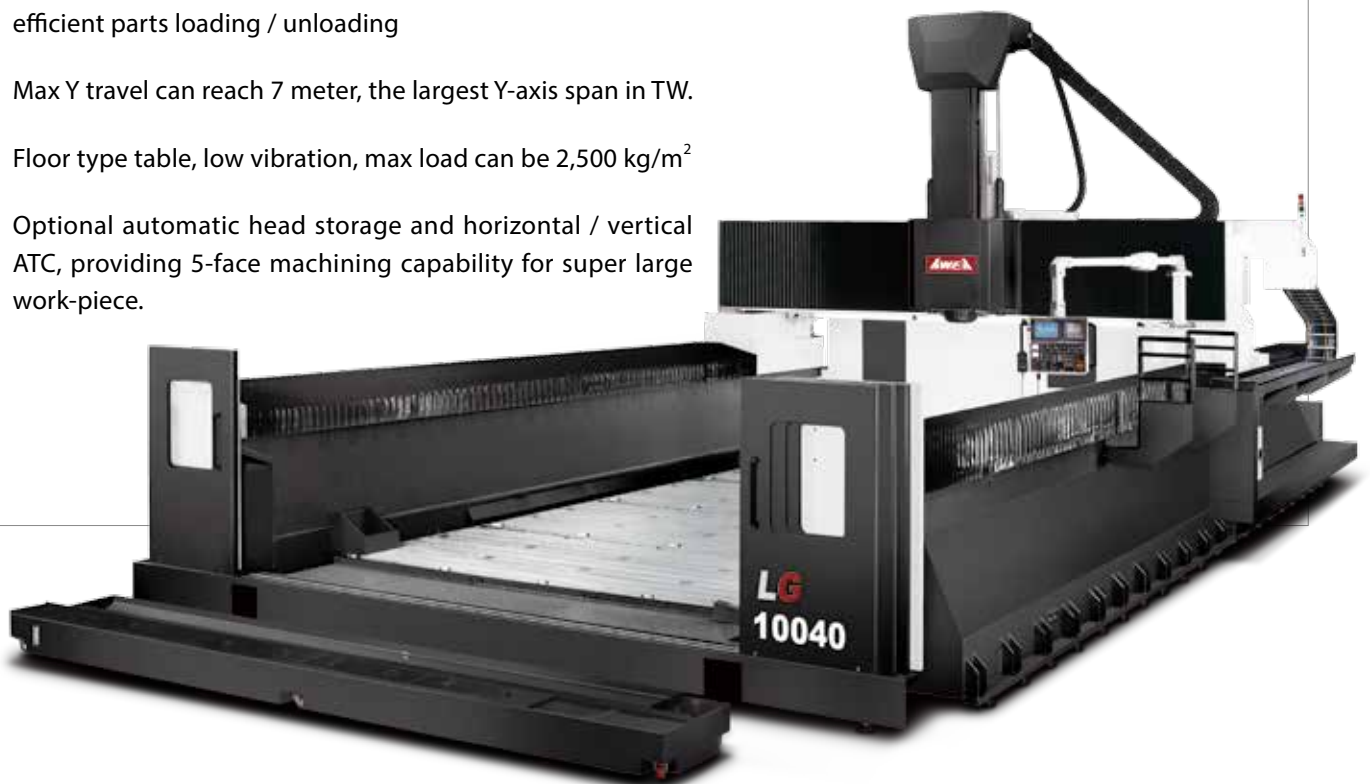

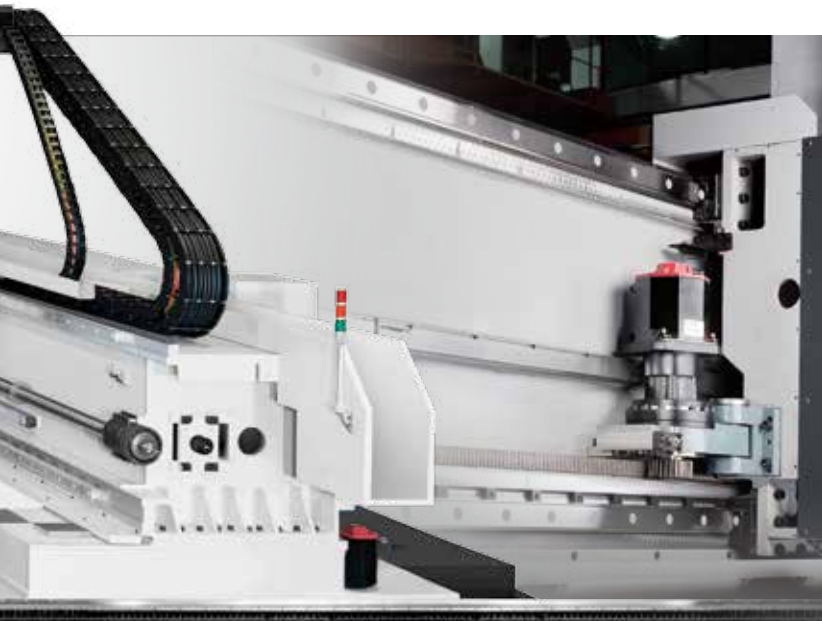

LG-20070 Largest Machining Center in Taiwan

X-axis Modular Design

The working table and side columns are all of modular design. The X-axis travel could be extended based on different machining requirements.

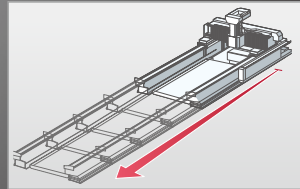

Adjustable Crossbeam Mechanism

Successfully overcome the physical limits, minimizing the deformation caused by the weight of the 7,000 mm super wide crossbeam, while ensuring optimal machining accuracy.

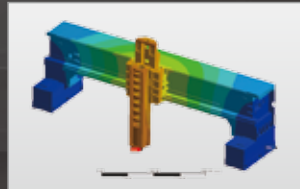

Patent No.
M377276



- 1 High torque gear spindle, optional high precision built-in spindle
- 2 Zero backlash rack & pinion (for X travel larger than 6 meter)
- 3 Multi heads storage compartment
- 4 Vertical / Horizontal ATCs

		LG-4030	LG-5030	LG-6030	LG-8030	LG-10030	LG-6040	LG-8040
X-axis travel	mm	4,000	5,000	6,000	8,000	10,000	6,000	8,000
Y-axis travel	mm	3,000				4,000		
Z-axis travel	mm	1,000 (1,200 / 1,400 Opt.)						
Dist. between columns (with water eliminator)	mm	3,500				4,500		
Table load capacity	kg/m ²	2,500						
Spindle speed	rpm	4,000 (6,000 / 8,000 / 10,000 Opt.)						
Spindle motor	kW	22 / 26 (Cont. / 30 min.)						

		LG-10040	LG-6050	LG-8050	LG-10050	LG-14050	LG-20070	
X-axis travel	mm	10,000	6,000	8,000	10,000	14,000	20,000	
Y-axis travel	mm	4,000	5,000				7,000	
Z-axis travel	mm	1,000 (1,200 / 1,400 Opt.)						
Dist. between columns (with water eliminator)	mm	4,500	5,500				7,500	
Table load capacity	kg/m ²	2,500						
Spindle speed	rpm	4,000 (6,000 / 8,000 / 10,000 Opt.)						
Spindle motor	kW	22 / 26 (Cont. / 30 min.)						

FM

Vertical Machining Center

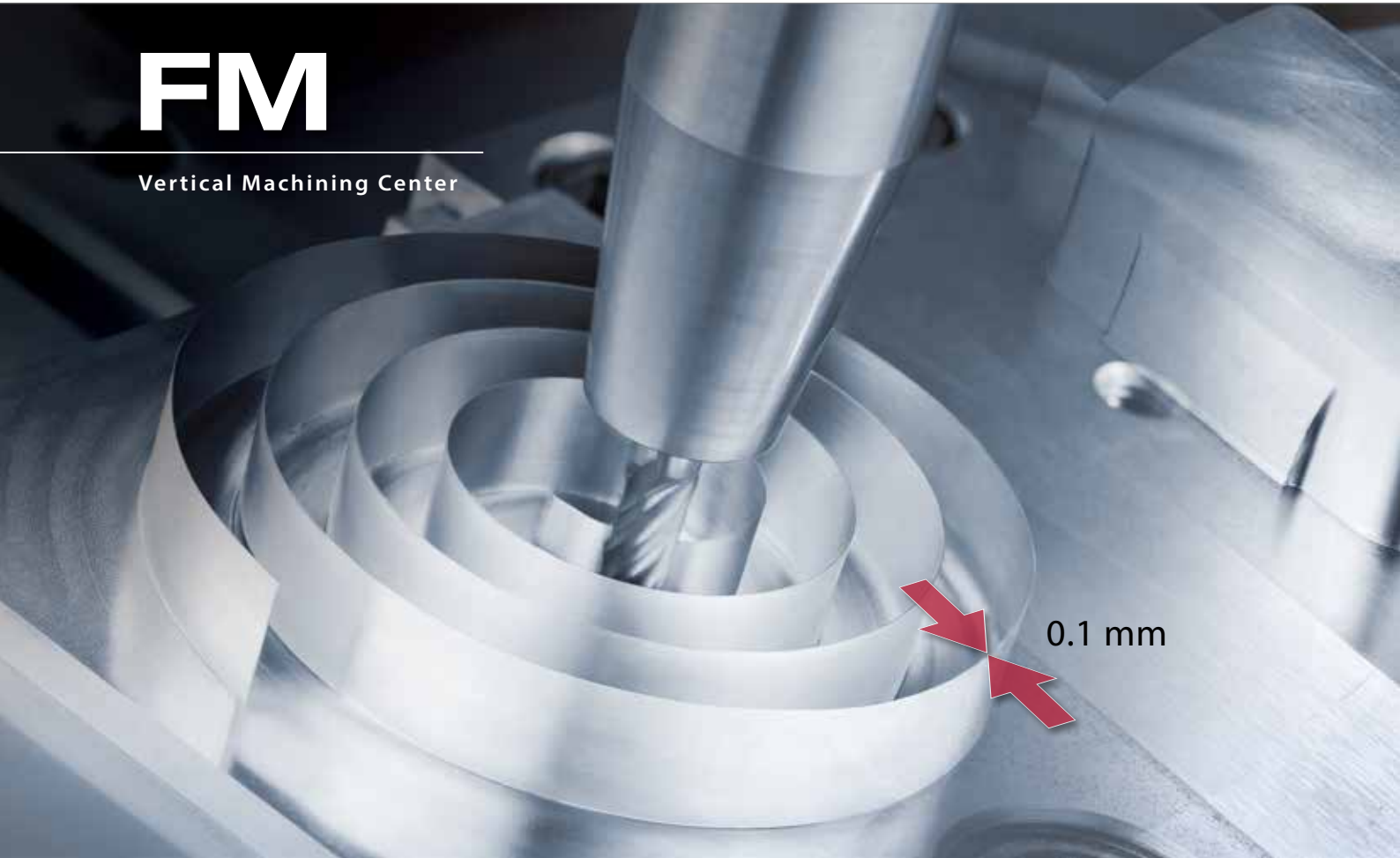

Bridge Type High Speed Machining Center



- Super high rigidity bridge type structure provides high speed machining capability.
- Modularized high speed spindle design, max speed is 30,000 rpm.
- Rapid feed rate for 3-axes is at 30 m/min ; cutting feed rate is at 24 m/min, provide efficient cutting solutions.
- Best models for precise mold and parts machining.



Modular high speed spindle >>



	Max. Speed	Max. Output
Built-in Spindle	20,000 rpm	18.5 kW
	21,000 rpm	24 kW
	22,000 rpm	30 kW
	30,000 rpm	24 kW
Direct-driven Spindle	12,000 rpm	18.5 kW
	15,000 rpm	18.5 kW

Applicable spindle is depending on different machine models, please check with your local dealer or sales representative.

Super rigidity bridge type structure >>

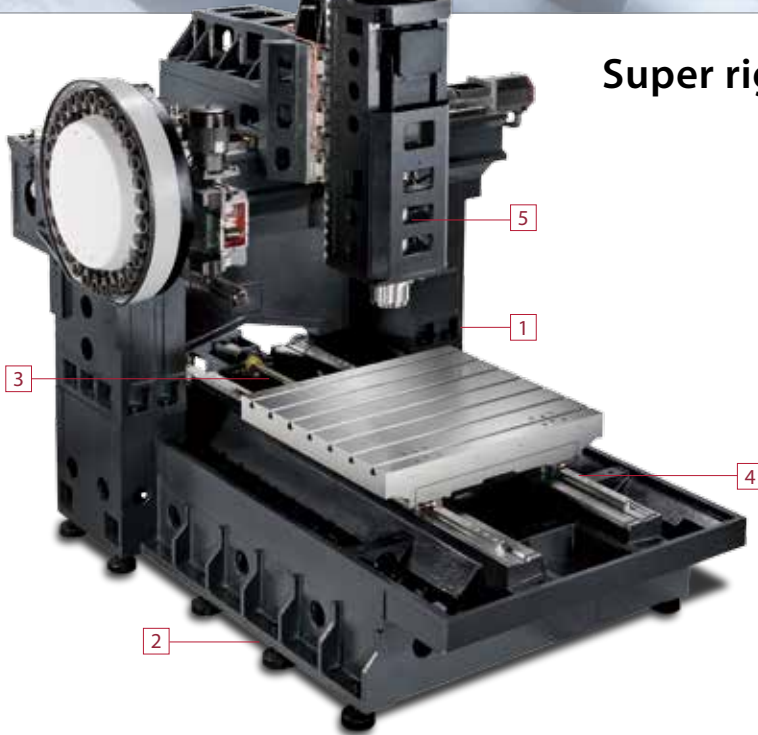

- 1 One-piece column & Bridge
- 2 Firm & solid bed
- 3 Precision pitch ball screws
- 4 Extremely precise, powerful roller liner guideway
- 5 Modular high speed spindle

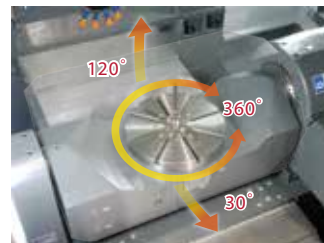

Rotary table for 5-face machining is optional.

		F-7	F-87	F-16	F-101
X-axis travel	mm	700	800	1,000	1,000
Y-axis travel	mm	500	700	600	1,000
Z-axis travel	mm	350	420	500	500
Table size (X x Y)	mm	770 x 500	850 x 700	1,160 x 600	1,100 x 1,000
Table load capacity	kg	600	800	1,000	2,000
Spindle speed	rpm	Built-in 21,000	Built-in 20,000	Direct-drive 12,000	
Spindle motor	kW	18 / 24 (Cont. / 30 min.)	15 / 18.5 (Cont. / 30 min.)	15 / 18.5 (Cont. / 30 min.)	

BM

Vertical Machining Center



High Rigidity Vertical Machining Center



- High stiffness box way design to fulfill heavy-duty machining needs.
- High torque gear spindle, optional belt spindle or direct drive spindle to meet your actual requirement.
- High reliability and high efficiency arm type tool magazine.
- Useful chip disposal system, the quantity of chip augers are adopted according to different models.

Heavy cutting solutions >>

High Torque Gear Spindle



Maximum Torque

470 N-m

2-step gear box design

BT40

Max. spindle speed reach up to 8,000 rpm which provide maximum torque output at 282 N-m under 375 rpm along with constant power at 11 kW.

BT50

Max. spindle speed reach up to 6,000 rpm which provide maximum torque output at 470 N-m under 375 rpm along with constant power at 18 kW.

Super Rigidity Box Way Design

- 3 axes are equipped with box ways which precisely grind through heat treatment, especially suitable for heavy cutting.
- Provide 4 box guide ways or complex 6 guide ways base according to model size to assure the most powerful support.
- Contact surfaces of all slides, column, ball screw bearing housings with the machine bed are hand scraped to provide maximum assembly precision and load distribution.



Compound six guide ways base (BM-2100 / BM-2500)

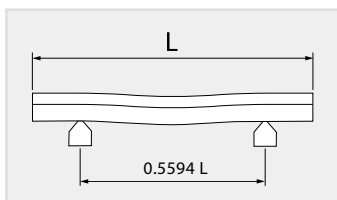

The BESSEL POINTS design provides maximum support for the Y-axis saddle.

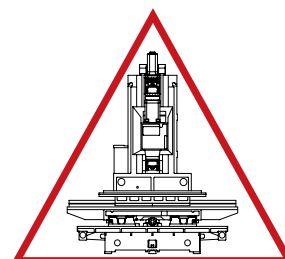

△ (Delta) machine structure provides heavy load and powerful cutting foundation.



		BM-850	BM-1020	BM-1200	BM-1460	BM-1400	BM-1600	BM-1800	BM-2100	BM-2500
X-axis travel	mm	850	1,020	1,200	1,400	1,400	1,600	1,800	2,100	2,500
Y-axis travel	mm	600			800			10,00		
Z-axis travel	mm	600			700			1,000		
Table size (X x Y)	mm	1,050 x 600	1,120 x 600	1,300 x 600	1,500 x 650	1,500 x 800	1,700 x 800	2,000 x 800	2,300 x 1,000	2,700 x 1,000
Table load capacity	kg	850	1,000	1,200	1,400	1,800	2,000	2,200	3,000	4,000
Spindle speed	rpm	Gear 8,000				Gear 6,000				
Spindle taper		BT40 (BT50 Opt.)				BT50 (BT40 Opt.)			BT50	

AF

Vertical Machining Center

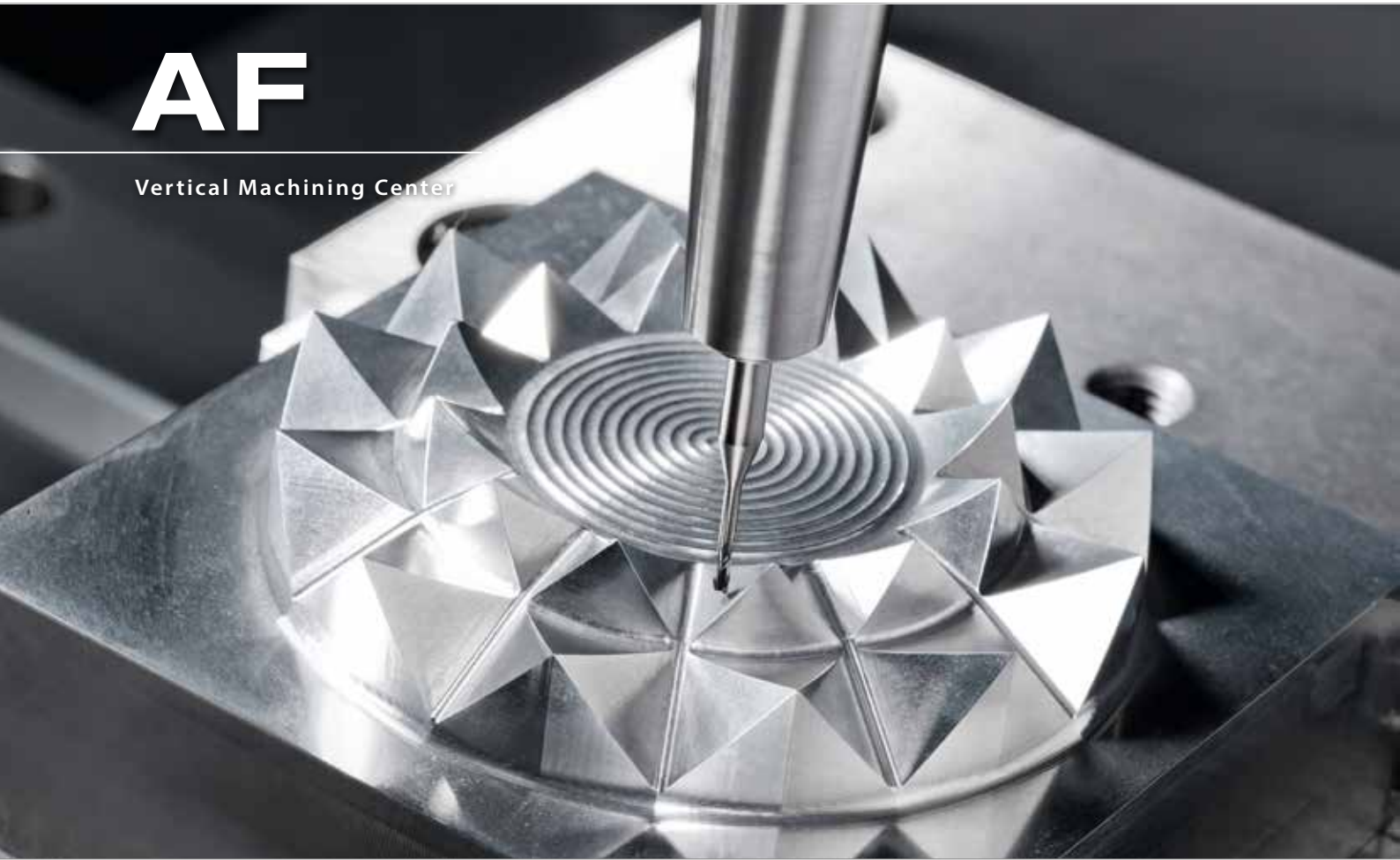

High Efficiency Vertical Machining Center

- High precision linear guide way design to fulfill mold machining needs.
- High speed direct drive spindle, optional gear spindle or belt spindle to meet your actual requirement.
- High reliability and high efficiency arm type tool magazine.
- Useful chip disposal system, the quantity of chip augers are adopted according to different models.



Precision mold machining solutions >>

High Speed Direct-driven Spindle



Max. RPM (Opt.)

15,000 rpm

High speed direct-driven spindle effectively separates the heat generated from the motor and minimizes thermal distortion, which meets the cutting requirements for mould machining

High Precision Linear Guide Ways

- 3 axes are equipped with high speed and high precision linear guide ways to provide the best controllability and movement efficiency.
- X-axis travel 1,400~1,800 mm model, the bed uses four linear guide ways design, and size of the bed will extend proportionally according to travel length in order to solve the overhang problem of working table and ensure the optimum support rigidity.



The bed uses four linear guide ways design (AF-1400 / AF-1600 / AF-1800)

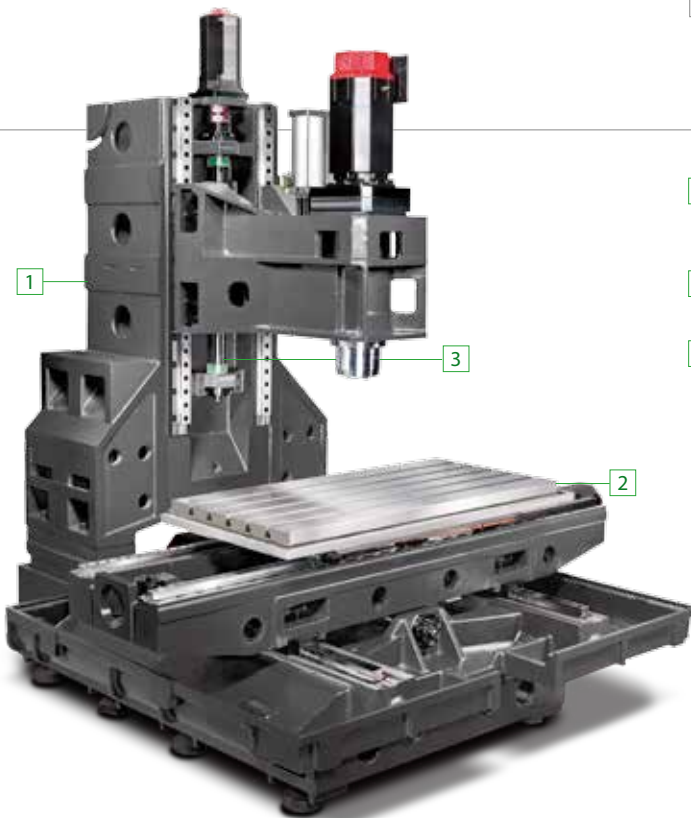

- 1 Δ (Delta) wide span column structure provides optimal machining rigidity, The headstock retains stability and accuracy even under high speed traveling.
- 2 Rib reinforced working table restrains vibration while increasing machining stability.
- 3 High precision dual screws with nuts rotary to ensure machining accuracy and heavy-duty capacity.



One-piece ball screw driving motor support and bearing support enable cutting force to spread evenly into casting body, so it efficiently enhances axial system of entire rigidity and prevents deformation of ball screw.

		AF-610	AF-650	AF-860	AF-1000	AF-1060	AF-1250	AF-1460	AF-1400	AF-1600	AF-1800	
X-axis travel	mm	610	650	860	1,020	1,060	1,250	1,400	1,400	1,600	1,800	
Y-axis travel	mm	450	510	600	550	600	620		800			
Z-axis travel	mm	450	510	600	635	600	620		800			
Table size (X x Y)	mm	700 x 450	750 x 510	1,000 x 600	1,200 x 550	1,200 x 600	1,350 x 620	1,500 x 620	1,500 x 800	1,700 x 800	1,900 x 800	
Table load capacity	kg	450	500	700	700	700	1,000	1,000	1,200	1,500	1,800	
Spindle speed	rpm	Direct-drive 10,000 / 12,000 / 15,000							Direct-drive 8,000			
Spindle taper		BT40							BT50			

AT

Tapping Center



High Speed Tapping Center

- Optional 12,000 / 15,000 / 20,000 rpm spindle speed.
- Both FANUC Oi-MD and MITSUBISHI M-70 are available.
- Compact size, space saving, higher factory space utility.
- Both chip collector and tank are separable, for easier maintenance.
- Optional chip wash down system, help to remove the chips more quickly.



High speed machining solutions >>

Axis-Feeding System

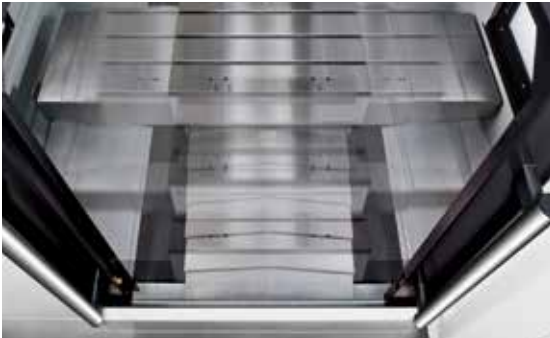

The powerful direct-drive servo motor provides high acceleration and deceleration which increases machining efficiency.

3 axes Rapids (Opt.)

60 m/min.

Axial Acceleration

1 G

ATC system



The standard 14T front-end magazine shortens non-machining time which increases productivity.

T-T (Opt.)

1 sec.

- 1 The high precision beveled ball bearings adopted with optimal span and two-support points design increases rigidity and durability for the spindle.
- 2 The motors and spindles use high rigidity coupling to reduce vibration caused by the lateral force from the spindle which ensures working stability and accuracy.
- 3 The one-piece MEEHANITE casting bed and Y-shaped column provides a solid support to ensure ultimate dynamic accuracy.
- 4 3 axes uses roller type linear guideways to provide great control and movement.
- 5 High rigidity table adapts optimized fulcrum design, providing a max load of 250 kg.

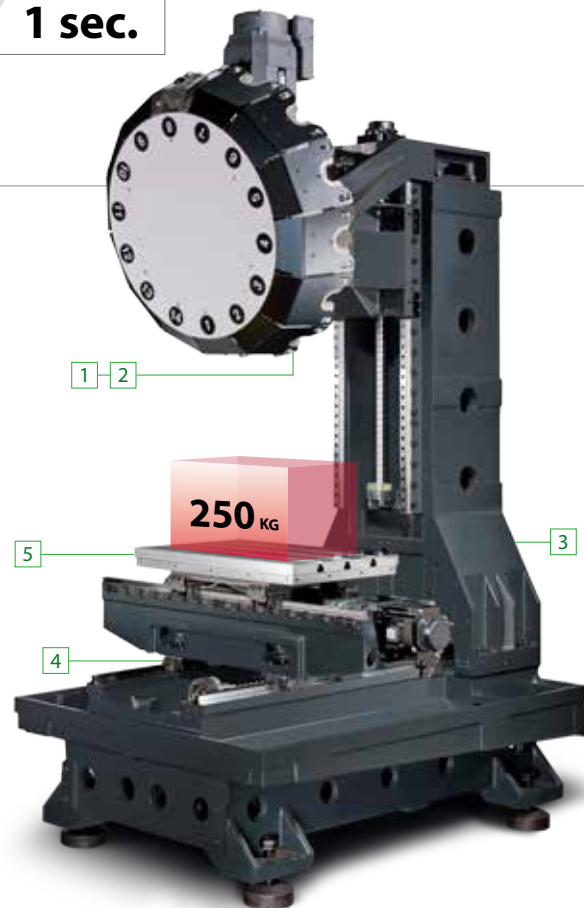

AT-510		
X-axis travel	mm	510
Y-axis travel	mm	400
Z-axis travel	mm	350
Table size (X x Y)	mm	610 x 400
Table load capacity	kg	250
Spindle speed	rpm	12,000
Spindle taper		BT30



The Product Line-up

Bridge Type 5-face Machining Center



19

MVP Series
Moving Cross Rail 5-face
Machining Centers

Travel X : 4,000 ~ 7,000 mm
Y : 3,200 ~ 4,000 mm
Z : 1,000 ~ 1,400 mm
W : 1,250 mm



21

HTP Series
Super Rigidity Bridge Type 5-face
Machining Centers

Travel X : 4,000 ~ 7,000 mm
Y : 2,500 ~ 4,000 mm
Z : 1,000 ~ 1,400 mm



23

LP-F Series
High Efficient Bridge Type 5-face
Machining Centers

Travel X : 2,500 ~ 7,000 mm
Y : 1,600 ~ 4,000 mm
Z : 760 ~ 1,400 mm



HVM Series
Bridge Type 5-face Machining
Centers

Travel X : 3,000 ~ 7,000 mm
Y : 2,500 ~ 4,500 mm
Z : 1,000 ~ 1,400 mm

Bridge Type 5-axis Machining Centers



25

MEGA5 Series
Bridge Type 5-axis Machining
Centers

Travel X : 3,000 ~ 20,000 mm
Y : 1,600 ~ 7,000 mm
Z : 1,000 ~ 1,400 mm
B : $\pm 100^\circ$ C : $\pm 240^\circ$



27

FMV-99
Gantry Type 5-axis Machining
Centers

Travel X : 800 mm
Y : 900 mm
Z : 660 mm
A : $-120^\circ \sim +30^\circ$ C : 360°



27

FMV-45
Gantry type 5-axis Machining
Centers

Travel X : 500 mm
Y : 450 mm
Z : 450 mm
B : $-180^\circ \sim +160^\circ$ C : 360°



LV Series
5-axis Machining Centers For Light
Materials

Travel X : 6,000 mm
Y : 3,000 mm
Z : 1,500 mm
B : $\pm 120^\circ$ C : $\pm 270^\circ$

Horizontal Machining Centers



AH Series
Horizontal Machining Centers

Travel X : 560 mm
Y : 560 mm
Z : 600 mm

Horizontal Boring Mills



29

MB Series
High Accuracy Horizontal Boring
Mills

Travel X : 1,500 mm
Y : 1,200 mm
Z : 900 mm
W : 500 mm



31

BL Series
Heavy-duty Horizontal Boring
Mills

Travel X : 2,000 ~ 4,000 mm
Y : 1,800 ~ 2,400 mm
Z : 1,300 ~ 1,700 mm
W : 600 mm

Tapping Centers



43

AT Series
High Speed Tapping Centers

Travel X : 510 mm
Y : 400 mm
Z : 330 mm

Bridge Type Machining Centers



35

LG Series
Gantry Type
Machining Centers

Travel | X: 4,000 ~ 20,000 mm
Y: 3,000 ~ 7,000 mm
Z: 1,000 ~ 1,400 mm



33

LP Series
High Performance Bridge
Type Machining Centers

Travel | X: 2,500 ~ 7,000 mm
Y: 1,600 ~ 4,000 mm
Z: 760 ~ 1,400 mm



33

SP Series
High Performance Bridge
Type Machining Centers

Travel | X: 2,100 ~ 4,000 mm
Y: 1,600 mm
Z: 760 mm



33

VP Series
High Performance Bridge
Type Machining Centers

Travel | X: 2,000 ~ 5,000 mm
Y: 1,200 mm
Z: 760 mm

Bridge Type High Speed Machining Centers



37

F-7
Bridge Type High Speed
Machining Centers

Travel | X: 700 mm
Y: 500 mm
Z: 350 mm



37

F-16
Bridge Type High Speed
Machining Centers

Travel | X: 1,000 mm
Y: 600 mm
Z: 500 mm



37

F-87
Bridge Type High Speed
Machining Centers

Travel | X: 800 mm
Y: 700 mm
Z: 420 mm



37

F-101
Bridge Type High Speed
Machining Centers

Travel | X: 1,000 mm
Y: 1,000 mm
Z: 500 mm

Vertical Machining Centers



39

BM Series
High Rigidity Vertical
Machining Centers

Travel | X: 850 ~ 2,500 mm
Y: 600 ~ 1,000 mm
Z: 600 ~ 1,000 mm



41

AF Series
High Performance Vertical
Machining Centers

Travel | X: 610 ~ 1,800 mm
Y: 450 ~ 800 mm
Z: 450 ~ 800 mm



41

AV Series
High Efficiency Vertical
Machining Centers

Travel | X: 610 ~ 1,400 mm
Y: 450 ~ 620 mm
Z: 450 ~ 620 mm



APC Series
Vertical Machining Centers With
Auto Pallet Changers

Travel | X: 850 mm
Y: 600 mm
Z: 600 mm



THE ULTIMATE MACHINING POWER

AWEA MECHANTRONIC CO., LTD.

HEADQUARTERS

629, Suezhetou Section, Kwanpu Rd.,
Wenshan Li, Xinpu, Hsinchu 305, Taiwan

TEL : +886-3-588-5191

FAX : +886-3-588-5194

CENTRAL TAIWAN SCIENCE PARK BRANCH

15, Keyuan 2nd Rd., Central Taiwan Science Park,
Taichung 407, Taiwan

TEL : +886-4-2462-9698

FAX : +886-4-2462-8002

E-mail : sales@awea.com



www.AWEA.com